











Unpacking





Before you begin using the device, please check the version you got and ensure that the following items are included in the shipped box:

Mainframe Accessories:

- | | | |
|---|---|---|
|  M3x5 screw x 4 |  M3x6 screw x 2 |  Silicon rubber sealing ring x 1 |
|  Back cover x 1 |  Cable Locking Plate x 1 |  Rubber Plug x 3(S,M,L) |
|  Rope x 1 |  Allen Wrench x 1 |  R27 X x 1 |
|  ST1.7x4 screw x 2 | | |





Wall mount

(Please find in On-wall Installation Kit Box):

- | | |
|---|---|
|  ST4x20 screw x 6 |  Screw fixing seat x 6 |
|  M4x30 screw x 2 |  wall-mounting box x 1 |

Flush mount

(Please find in In-wall Installation Kit Box):

- | | | |
|---|--|--|
|  ST4x20 screw x 6 |  Screw fixing seat x 6 | |
|  M4x10 screw x 6 |  Flush-mounting bracket x 1 |  Embedded box x 1 |

Product Overview

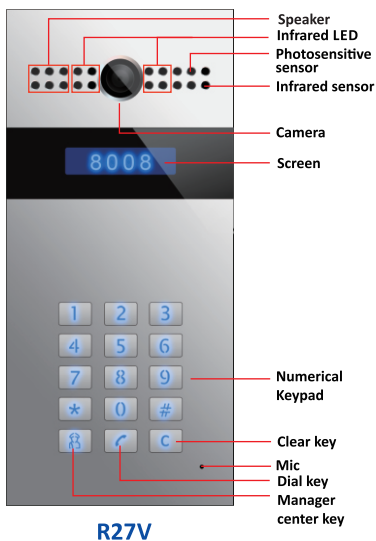
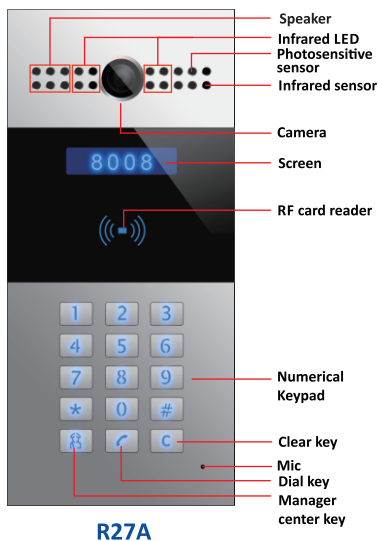

Installation

Step 1: Bracket/Box Installation

Wall Mounting

With 86 embedded box in the wall

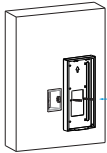

Fix the wall-mounting box on 86 embedded box with two M4x30 screws.

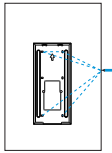

Mark the four holes of the wall-mounting box on the wall.

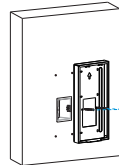

Take down two M4x30 screws and wall-mounting box.

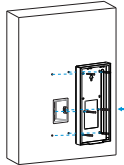

Fix the wall-mounting box with four ST4x20 screws and two M4x30 screws.

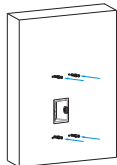

Insert the screw fixing seats into the holes.

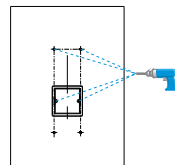

Use a hand drill with 5mm diameter bit to make holes in the marked positions.

Without 86 embedded box in the wall

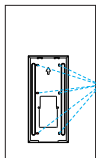

Mark the six holes of the wall-mounting box on the wall.

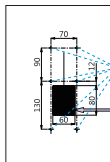

Use a hand drill with 5mm diameter bit to make the hole in marked positions. Dig out a square hole (height*width*depth=80*60*50mm).

*Please note the relative position in the left figure and the maximum error should be less than 5mm.

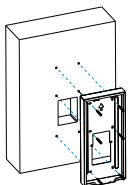

Fix the wall-mounting box with six ST4x20 screws.

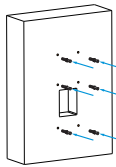

Insert the screw fixing seats into the holes you drilled before.

Flush Mounting

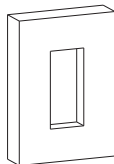

Dig out a square hole (height*width*depth=262.5*121*60mm).
Note: The size of the hole should be a little larger than recommended value that can accommodate all cables.

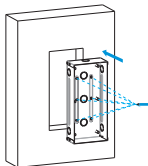

Insert the embedded box into the hole and make sure the cables of the device can route through the cable hole. Then mark the six holes of the wall embedded box on the wall.

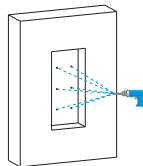

Take down the embedded box, then use a hand drill with 5mm diameter bit to make holes in the marked positions.

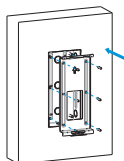

Use six M4x10 screws to fix the flush-mounting bracket on the embedded box.

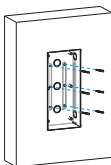

Place the embedded box into the square hole until the edges of which align to the wall and make all cables go through the cable hole. Fix the embedded box with six ST4x20 screws.

Note: The embedded box can not over the edge of the square hole.

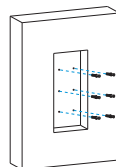

Insert the screw fixing seat in the hole you drill before.

Without ST4x20 screw, please follow the below installation method.

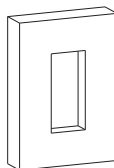

Dig out a square hole (height*width*depth=262.5*121*60mm).
Note: The size of the hole should be a little bigger than recommended value that can accommodate all cables.

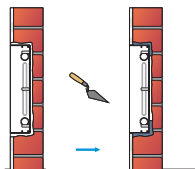

Use cement or non-corrosive structural adhesives to fill the gap between the wall and embedded box. Wait the adhesive material desiccation, go to the next step.

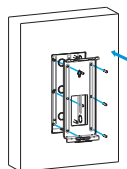

Use six M4x10 screws to fix the flush-mounting bracket on the embedded box.

Step 2: Back cover Installation

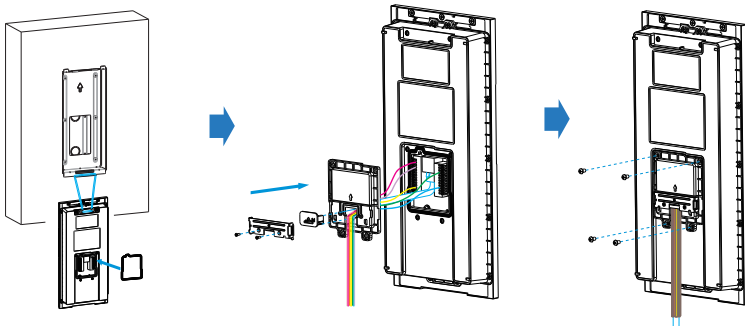

For convenient wiring, hang R28X on the wall-mounting box/ flush-mounting bracket with rope. Then insert the silicon rubber sealing ring into the groove.

Make cables go through the back cover, connecting to the corresponding interfaces of the main board. Choose a suitable size rubber plug to compress cables, then fasten the locking cable plate with ST1.7x4 screws.

Use four M3x5 screws to fix the back cover.

Step 3: Device Mounting

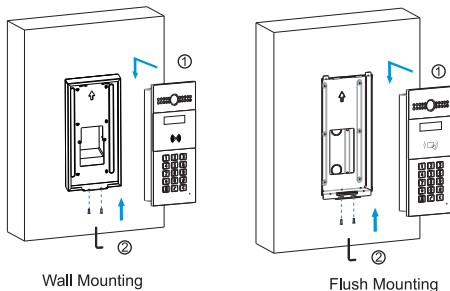

1. Place the device into the wall-mounting box/ flush-mounting bracket until the edges of which align to the wall. Then pull the device downward and ensure the groove of it hooks to the lock catches of the back box.

2. Use the Allen wrench to tighten the device with two M3x6 screws.

Application Scenario

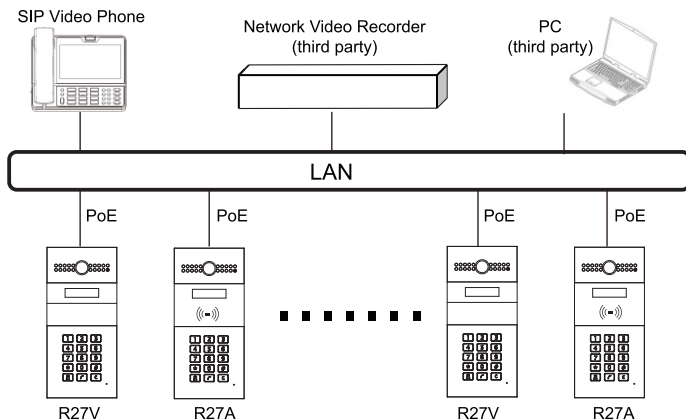

Conguration

- 1.IP Address Checking: Press *2396# to enter administrator setting interface. Click **System Information** to get the IP address. R27X uses DHCP by default.
- 2.Account Registration: On web UI, go to the path: **Account -> Basic** page to register account and fill in the account information. (*Please refer to user manual for more information*)
- 3.DTMF Code Configuration: On web UI, go to the path: **Intercom -> Relay -> Relay ID/DTMF** and choose the DTMF code number in corresponding area.

Operation

Make a call:

Input the room number, press Dial key to make a call.

Receive a call:

R27X supports Auto Answer by default. Incoming calls will be answered automatically.

Unlock by DTMF:

During the call, press the corresponding DTMF code of answer unit to unlock R27X remotely.

Unlock by Private Key:

In the idle, enter "**# + password + #**" or "**password + #**" to open the door. (The latter is used for New version. Go to **web UI - Intercom - Basic - Display Type** to switch Old or New version UI.)

Unlock by RF Card(Optional):

Place the predefined RF Card in the RF reader area to open the door.

Notice Information

Akuvox R27X firmware contains third-party open source software under the terms of the GNU General Public License(GPL). Akuvox is committed to meeting the requirements of the GNU General Public License (GPL) and will make all required source code available.

The source code of software under the terms of GNU GPL can be downloaded online:<http://www.akuvox.com/gpl>.

Information contained in this document is believed to be accurate and reliable at the time of printing. This document is subject to change without notice, any update to this document can be viewed on Akuvox' s website: <http://www.akuvox.com> © Copyright 2019 Akuvox Ltd. All rights reserved.



AKUVOX (XIAMEN) NETWORKS CO., LTD.

ADD: 10/F, NO.56 GUANRI ROAD, SOFTWARE PARK II, XIAMEN 361009, CHINA
www.akuvox.com

